



FFL4E

Future Freight Loco for Europe

Shift Freight to Rail: Midterm Event for S2R Projects
Vienna, 18.04.2018

- Introduction
- Future freight locomotive
- Full electric last mile propulsion
- Long trains
- Summary and Outlook

- The FFL4E aims at developing key technologies for future **energy efficient** freight locomotives, allowing highest **operational flexibility** and providing attractive and **competitive rail freight services** to the final customer.

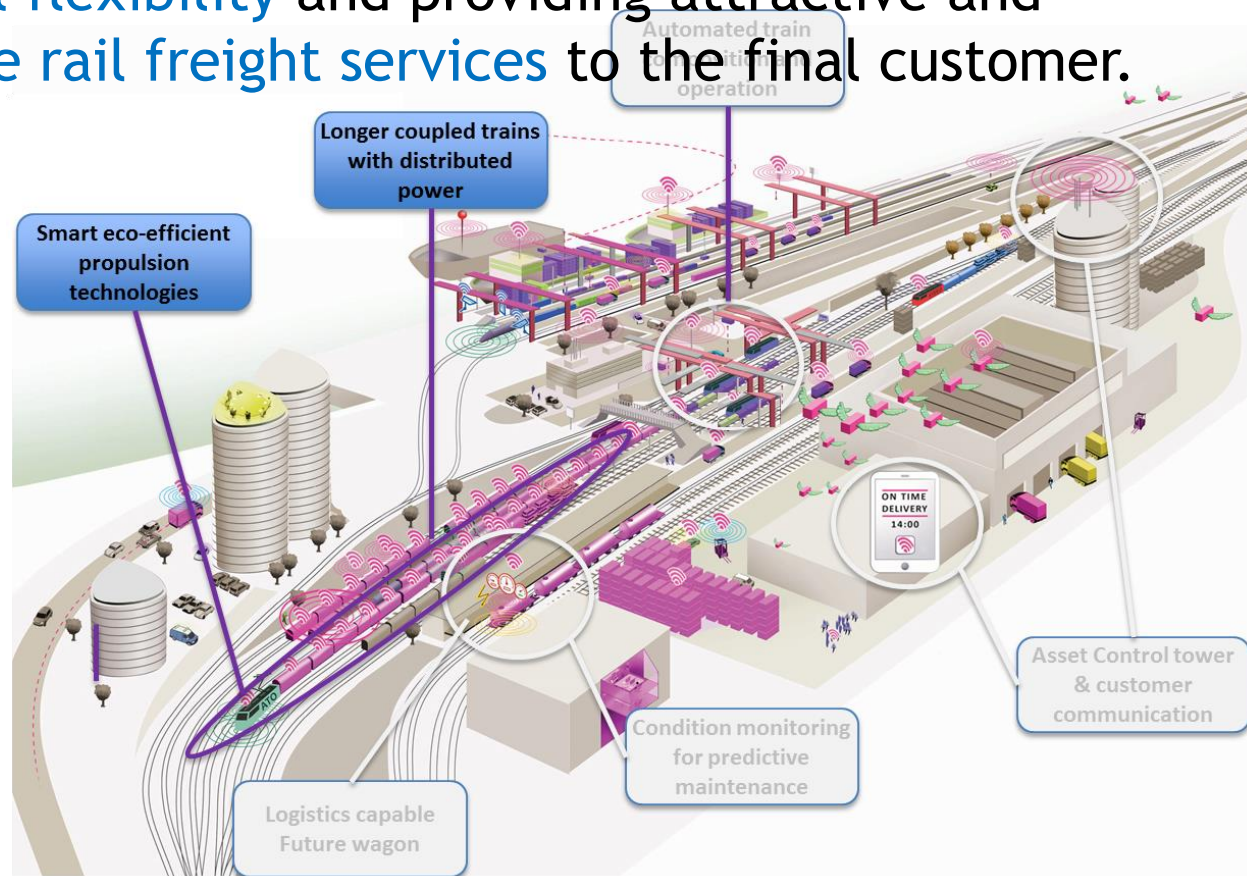

- **Extreme flexibility:** operation on non-electrified and electrified lines without the need of changing the locomotive. This requires hybrid propulsion technologies, and includes last mile propulsion systems
- **Competitive rail freight services:** Remote control for distributed power, thus, allowing the increase of the train length up to 1,500 m and consequently improving the cost efficiency of rail transport. This includes also technologies that reduce LCC (e.g. low wear locomotive bogie)
- **Energy efficiency:** Recuperation of braking energy as much as possible, store it onboard and reuse it whenever required, for traction purposes, for peak shaving or to supply auxiliaries and others

- FFL4E is structured as follows:
 - 2 WPs for Management and Coordination
 - 3 technical WPs
 - 1 WP for dissemination

- FFL4E is being led by: Bombardier Transportation

- Project Partners are:
 - Bombardier Transportation
 - Faiveley Transport Italia
 - Trafikverket
 - Deutsche Bahn
 - CAF Power & Automation
 - VVA
 - AVL List

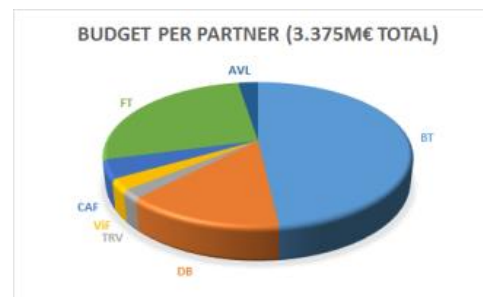
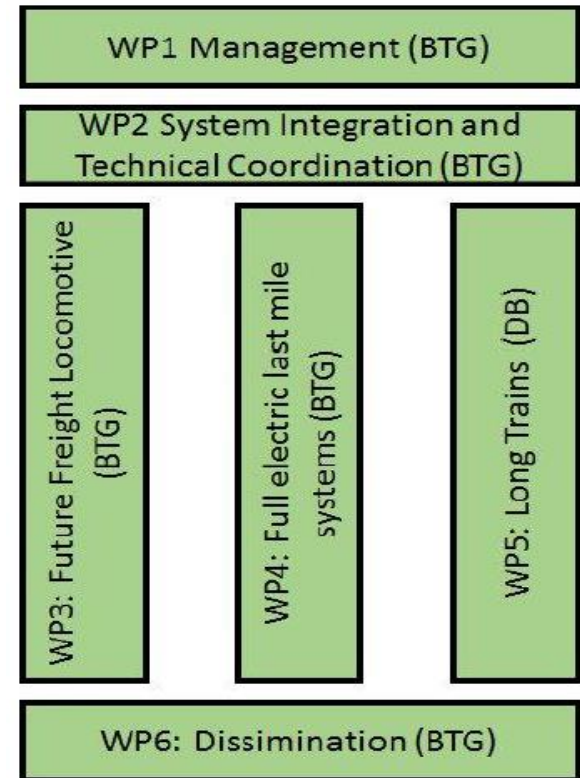

- Introduction
- Future freight locomotive
- Full electric last mile (LM) propulsion
- Long trains
- Summary and Outlook

- S2R FFL4E project studies the hybridization of propulsion system to further increase the functionality of electric locomotives
- Focus is on powerful energy storage systems that will allow:
 - Last mile run
 - Peak shaving
 - Backup mode
 - Energy Efficiency
 - Power Boost
 - Electric Mode
- FFL4E studies also how to decrease wear on powered locomotive bogies by means of radial steering systems

- Analysis of the key performance figures of existing locomotives and their commercial use
- Focus on Last Mile Run
- Modelling of a locomotive traction chain in simulation tool
- Real Track profiles, connecting towns with industry companies in Europe, used for simulation and calculation of OESS size:
 - TP1: Bruck an der Mur – Paper Mill in Gratkorn
 - TP2: Zeltweg – Pöls
 - TP3: Bruck an der Mur – Magna Steyr in Graz
 - TP4: Lüneburg – Hamburg

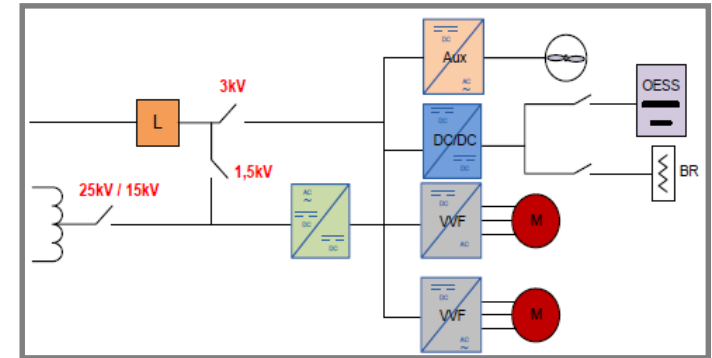

- Simulation with AVL Cruise M simulation tool
- For the given system architecture and for different real track profiles, the ideal OESS size was evaluated.

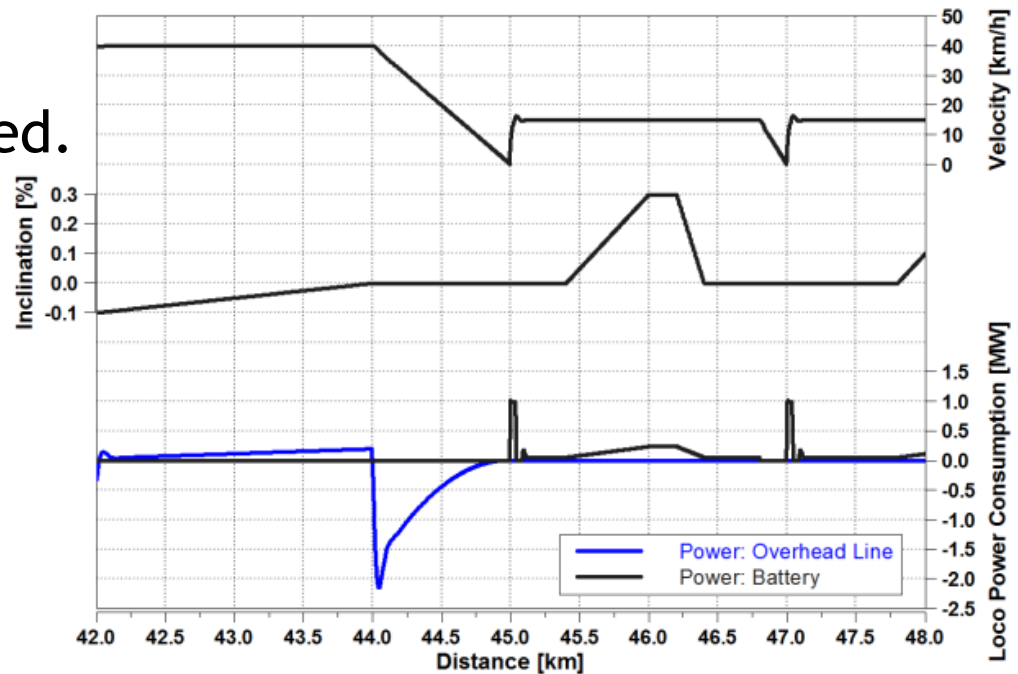
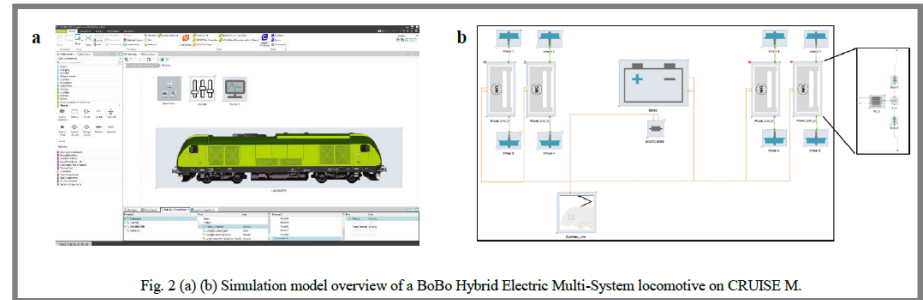

➤ Summary of OESS for the various use cases analysed:

Table 2. OESS characteristics of a hybrid electric freight locomotive for Last Mile application in four different track profiles.

Track profile and OESS characteristics		TP1	TP2	TP3	TP4
Track profile	Track profile	TP1	TP2	TP3	TP4
	Distance with battery [km]	10	14.5	11.8	7
	Altitude [m]	2	114	1	0
	# of stops [-]	3	-	1	3
	Train load and locomotive weight [t]	1500	←	←	←
OESS charac.	Battery power max. (incl. aux. & losses) [MW]	1.2	1.2	1.2	1.2
	Battery traction power max. [MW]	1	1	1	1
	Battery size – Energy point [kWh]	190 (6.3 C-rate)	1095 (1.1 C-rate)	180 (6.7 C-rate)	145 (8.3 C-rate)
	Battery size – Final [kWh] at 5.0 -Crate	240	1095 (1.1 C-rate)	240	240
	Battery size – Final [kWh] at 2.5 C-rate	480	1095 (1.1 C-rate)	480	480

- Introduction
- Future freight locomotive
- Full electric last mile (LM) propulsion
- Long trains
- Summary and Outlook

- Last Mile (LM) Propulsion System for Railway Applications first proposed by Bombardier Transportation few years ago, was a disruptive and successful innovation
- Today, small diesel engines with 200-300kW
- Next generation: hybrid approaches or full electric solutions, with following added value:
 - Increase in tractive power
 - Emission free operation over a certain distance
 - Energy recuperation into battery
 - Environmental friendly recharging of the battery from the catenary

- Analysis done in WP3 (Future Freight Locomotive) summarizes
 - Ideal battery size: 500kWh
 - Ideal battery power: 1MW
- Selected architecture:
 - A given number of smaller building blocks, e.g. 50kWh, arranged in parallel strings, each with an own BMS, TCU and DC/DC converter
- Advantages of this approach:
 - Balancing simpler
 - Higher safety
 - Lower maintenance efforts
 - Better adaption to the various customer needs (including retrofit)

- FFL4E is developing the demonstrator
- Main components are:
 - The Bombardier water cooled Primove Li-ion battery (nMNC)
 - 49kWh, 127kW continuous, 400kW peak (20s)
 - 440 mm x 1780 mm x 610 mm, 667 kg
 - One dedicated thermal conditioning unit
 - One DC/DC converter
 - Integration into one sealed cubicle to be placed in the machine room

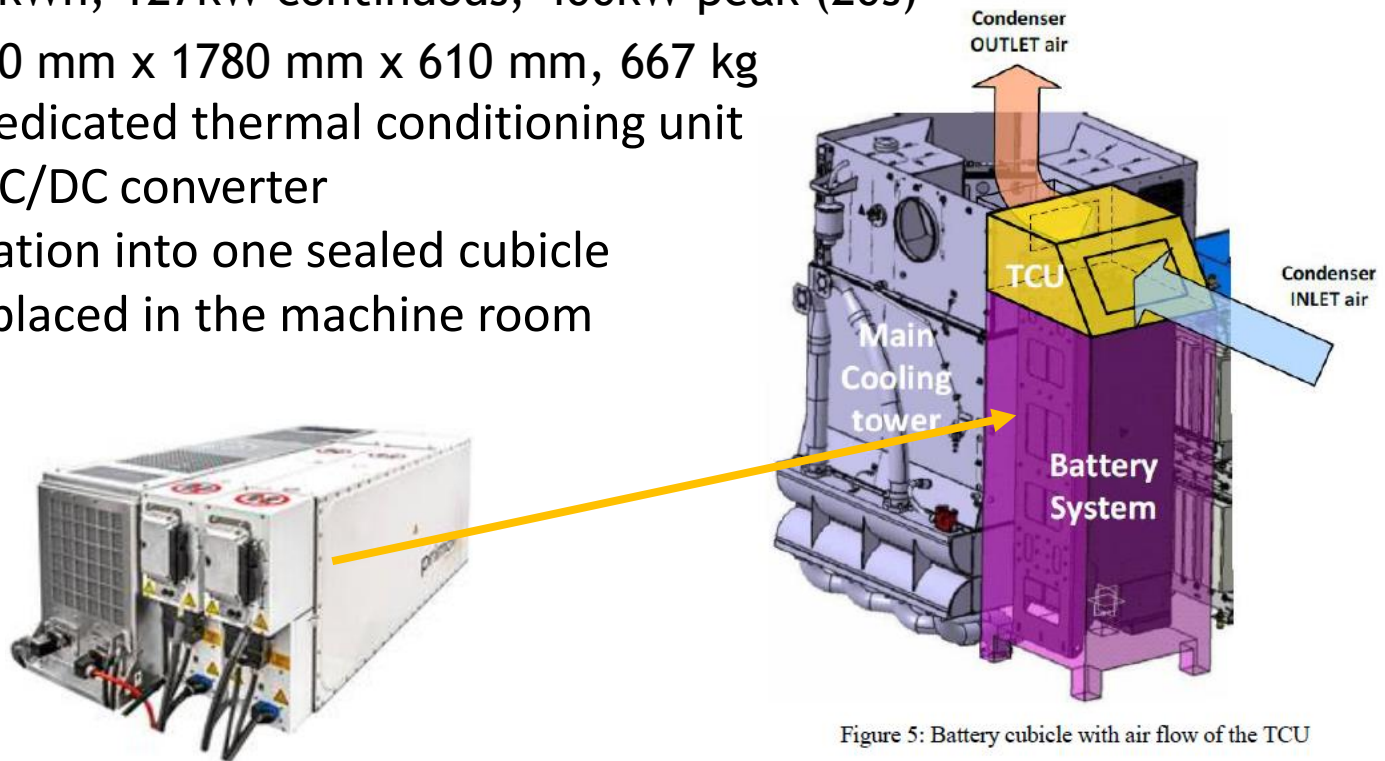
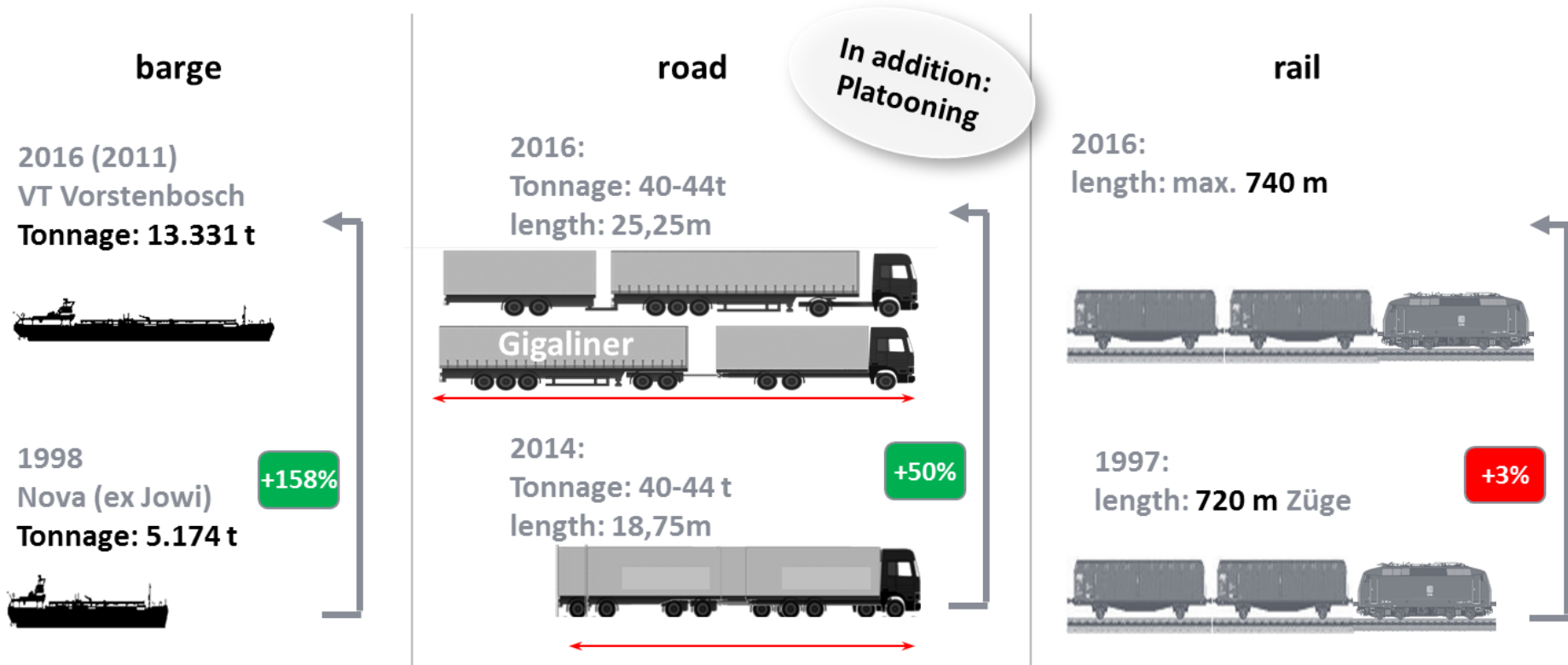

Figure 5: Battery cubicle with air flow of the TCU

- Introduction
- Future freight locomotive
- Full electric last mile propulsion
- Long trains
- Summary and Outlook

- Rail lags behind road and barge concerning transport efficiency

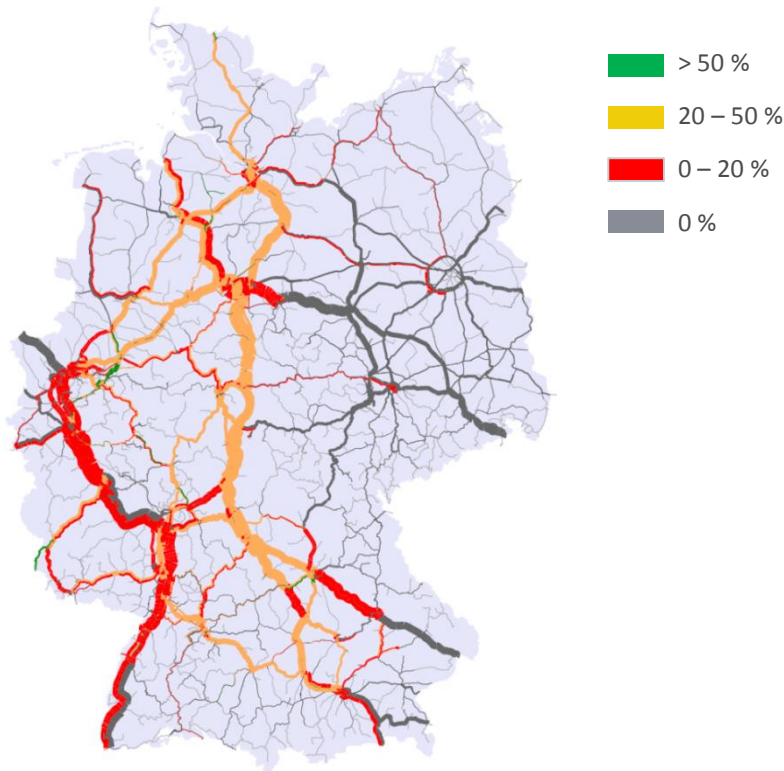

- Currently only a small percentage of freight trains runs with the maximum train length of 740 m

Percentage freight trains \geq 700m train length

Main reasons for small train lengths

- **Infrastructure** is not prepared for 740 m trains (mainly due to overtaking stations)
- **Missing technology for Distributed Power**
-> max. loads of trains are restricted to coupling hook load limits

- Gradients of infrastructure restricts maximum train loads significantly

Coupling hook load limits due to gradients of infrastructure

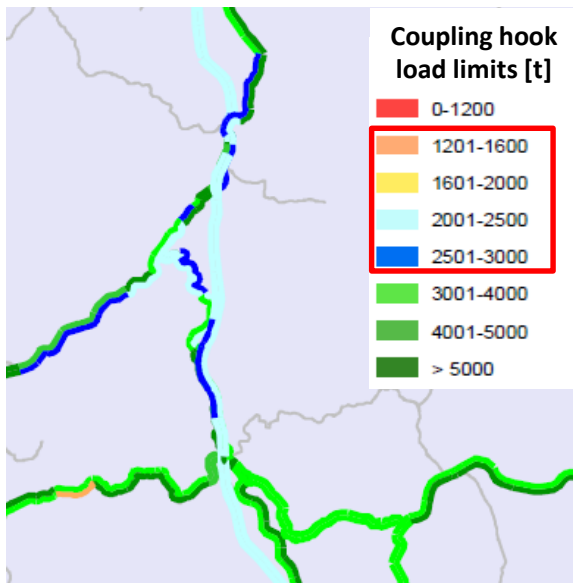

Restrictions for today's operation

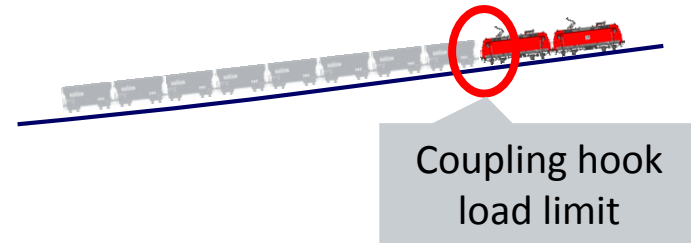

- The gradients of infrastructure restricts max. train loads
- Esp. for heavy load trains (coal, mineral oil...) load restrictions lead to short trains of 400 - 500 m

- Distributed Power enables RUs to run heavier and longer trains

Today's operations

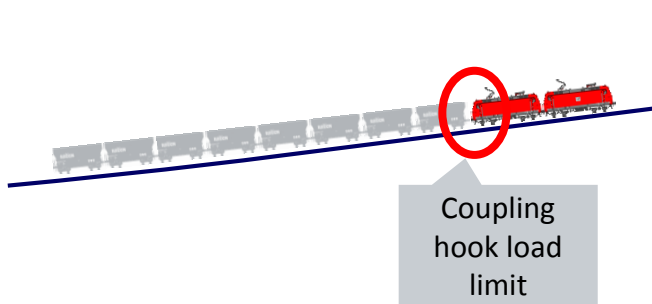

Future operations with Distributed Power

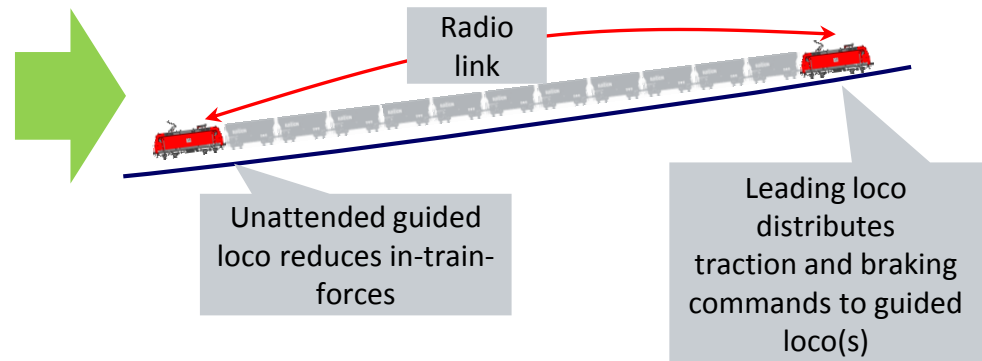

- Coupling hook load limits restricts max. load of freight trains
- Distributed Power reduces in-train-forces
- Distributed Power enables RUs to run much heavier and longer trains using the same resources
- No Infrastructure adaptations needed

- Distributed Power opens the path to 1,500 m long trains

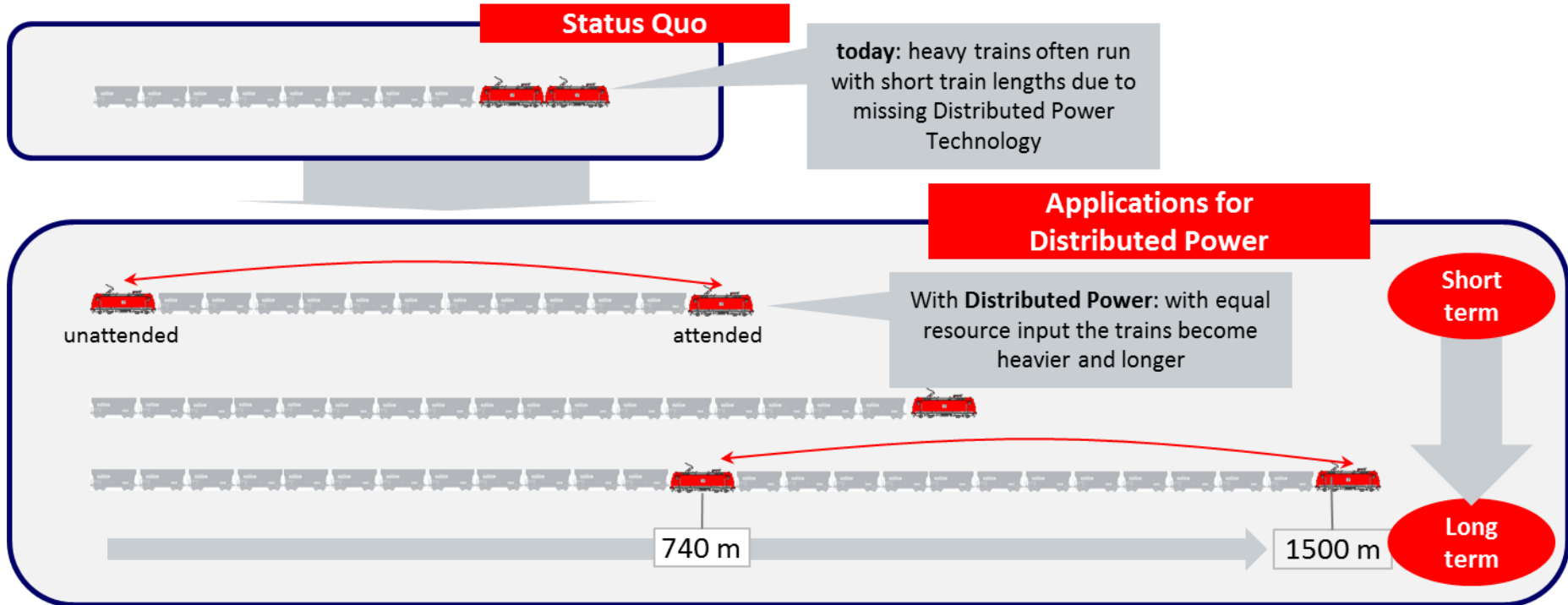

- FFL4E develops Distributed Power technology for the European market

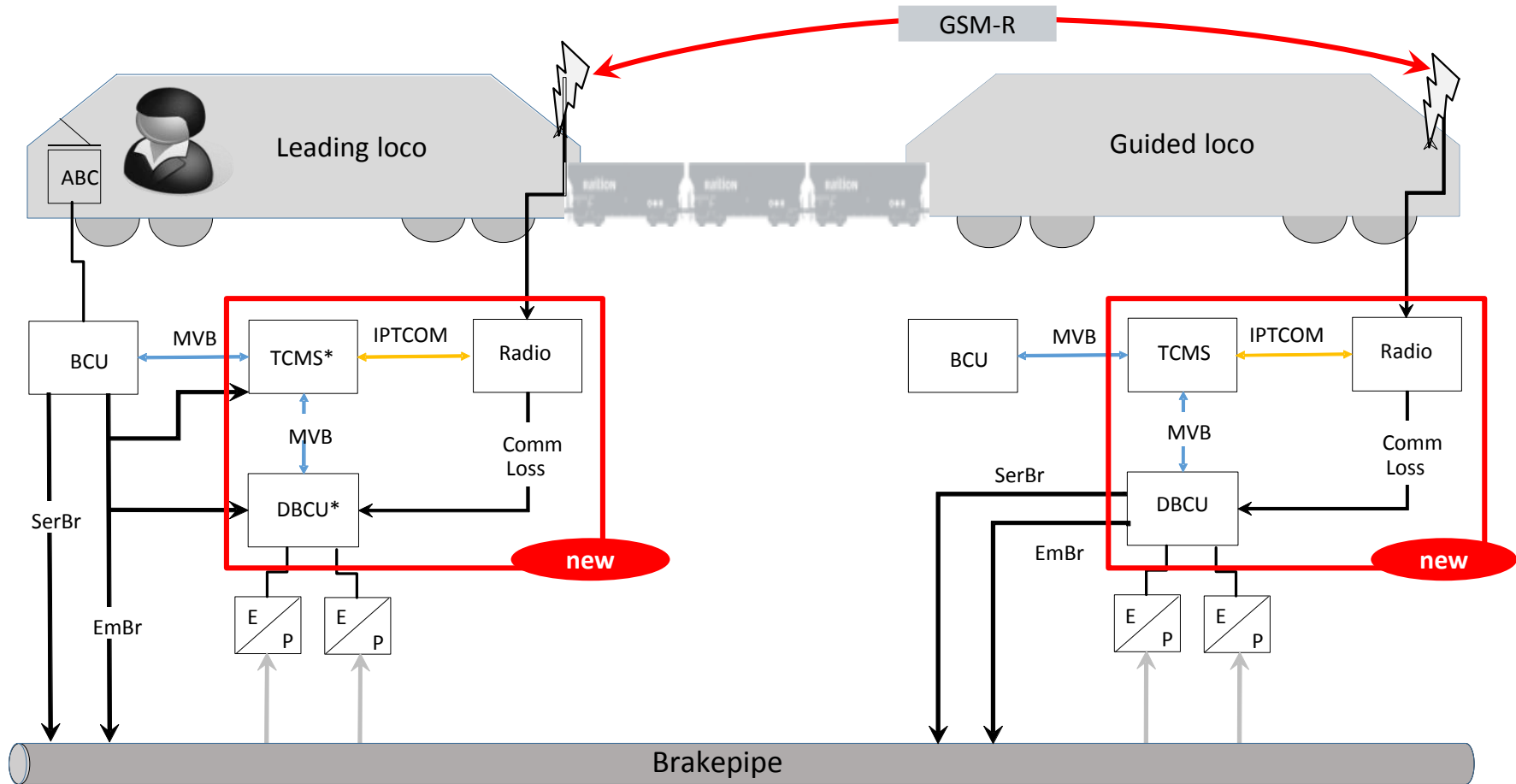

*TCMS: Train Control Management System, DBCU: Distributed Brake Control Unit

- Distributed Power will be demonstrated on a coal train Amsterdam - Munich

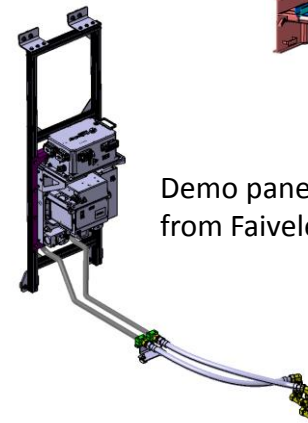
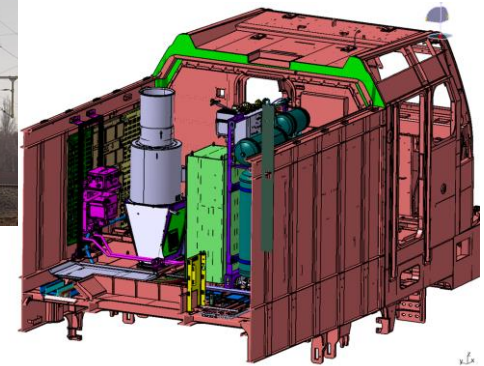
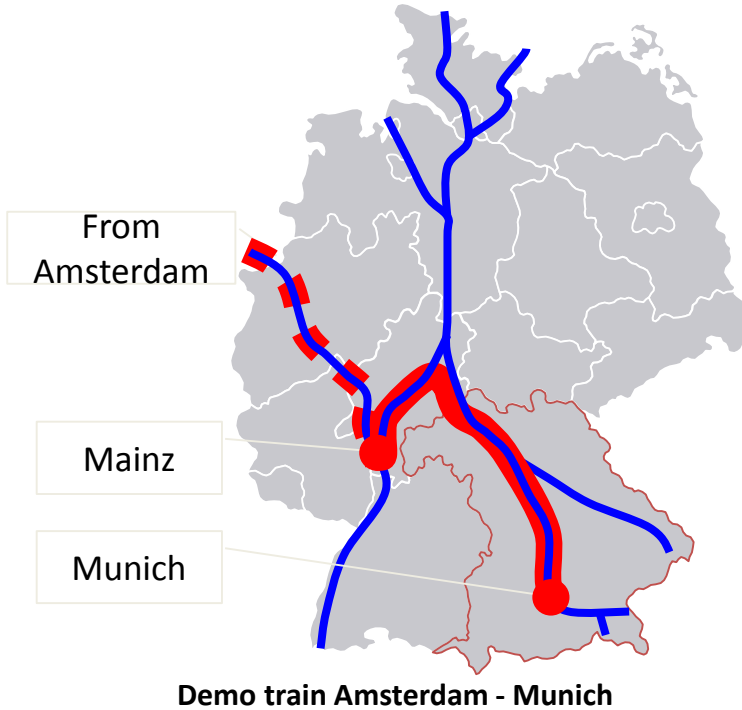

- Introduction
- Future freight locomotive
- Full electric last mile propulsion
- Long trains
- Summary and Outlook

- FFL4E is developing two demonstrators:
 - Full Electric LMB
 - Radio Remote Control for Distributed Power

- FFL4E is literally addressing the KPIs stated in the MAAP:
 - Increase of Energy efficiency
 - Increase of competitiveness
 - Doubling of capacity

- After some initial problems, work proceeding well

Thank you for your attention



